



Congratulations on your purchase of SAWO DRAGONFIRE sauna controls.
Please read the manual carefully before using the control.



FIRECONTROL

INSTRUCTIONS MANUAL

Table of Contents

1. Introduction of the Dragonfire controls	3
1.1 Precautions	3
2. Direction of Use	4
2.1 Turning on the Control Unit	4
2.2 Switching the Heater or Steamer On	5
2.2.1 Temperature	6
2.2.2 Relative Humidity	6
2.2.3 Session Time	7
2.2.4 Fan	7
2.2.5 Sauna Session	7
2.2.6 Steamer Session	7
2.3 Switching the Control Unit On/Off	8
2.3.1 Cabin Light	8
2.4 Pre-run Timer	9
2.4.1 Settings	9
2.4.2 Pre-run Timer	9
2.4.3 Pre-run Timer for Domestic Saunas	9
2.4.4 Pre-run Timer for Public Saunas with Weekly Timer	11
2.5 Changing the Settings	13
2.6 Other Dragonfire Control Features	14
2.6.1 Key Lock	14
Technical Diagram	15
2.7 Combi Features	17
2.7.1 Steamer	17
2.7.2 Humidity & Temperature in Sauna	17
2.7.3 Cabin Drying	17
2.7.4 Water Refill	18

3. Remote and Alarm Connections	19
3.1 Emergency Alarm	19
3.2 Remote On	19
4. Assembly and Installation	20
4.1 Control Unit to Heater Connection Diagram	20
4.2 Power Controller	21
4.3 Contactor Unit	21
4.4 Sensors	22
4.4.1 Sensor Location with Heaters Mounted on the Wall	22
4.4.2 Sensor Location with Heaters Mounted on the Floor	23
4.5 Maximum Session Time	23
4.6 Door Sensor (Optional)	24
4.7 Fan (Optional)	24
4.8 Dimmer (Optional)	24
4.9 Installation for Power Controller with Built-in Control Panel	24
4.10 Installation for Separate Control Panel	25
4.11 The Control Unit Main Switch	25
5. Troubleshooting	26
6. Symbol Reference	28

1. Introduction of the Dragonfire Control

Congratulations on your purchase of Dragonfire Control Unit!

Dragonfire Control Unit is developed to enhance your sauna bathing with a variety of features. It can adjust temperature, humidity, ventilation and light option in your sauna.

The following information provides you with instructions on adjusting the settings of the control unit. Please, read this instruction manual carefully before using the control unit. Familiarization of the key functions will give you a more enjoyable sauna experience.



1.1 Precautions

1. Only a qualified electrician is allowed to make the electrical connections and repairs on the unit. Use original parts only.
2. Disconnect the Power Controller and the Contactor Unit from the electrical circuit before installation, opening the lid of the power controller or contactor unit and repair.
3. Check power supply rating before installation.
4. Check the correct location of the sensor in the installation section of the manual. It is very important to place the temperature sensor correctly as it closeness of the air ventilation cools down the sensor and may lead to overheating.
5. The control unit can be operated on a room temperature 0-40°C. Do not install the control unit inside the sauna room!
6. Do not pour water in the control unit or clean it with wet cloth. For cleaning purposes, use a cleaning cloth that has been only slightly moistened with a mild soapy solvent (dish detergent).

2. Direction of Use

2.1 Turning on the Control Unit

When turning on the power controller, Dragonfire stainless steel touch will a turn on and automatically go to off-mode.



Then, the control unit will go to OFF mode, where you can switch on the heater, use lights, activate key lock and go to assy-mode

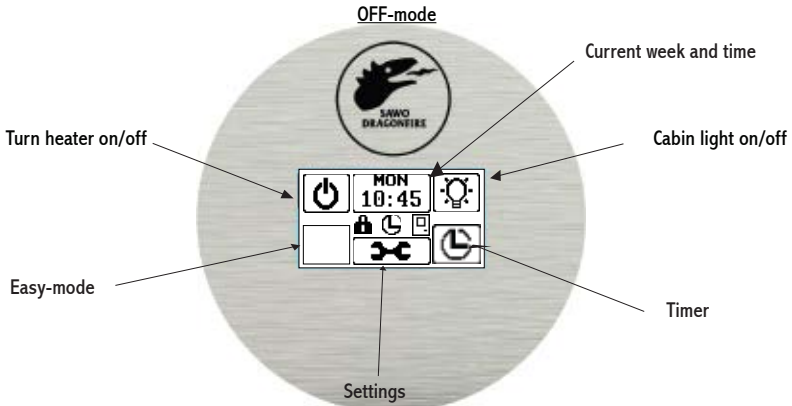

In easy mode some of the buttons are hidden. This feature makes Dragonfire easy and fast to use. Long press the hidden easy-button for 10 seconds to activate easy-mode. In easy-mode it is still possible to use the heater, steamer and adjust cabin light.

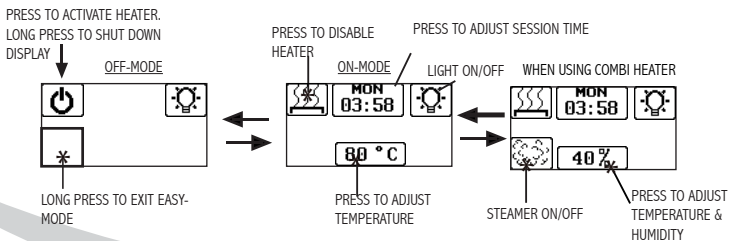



2.2 Switching the Heater or Steamer *ON

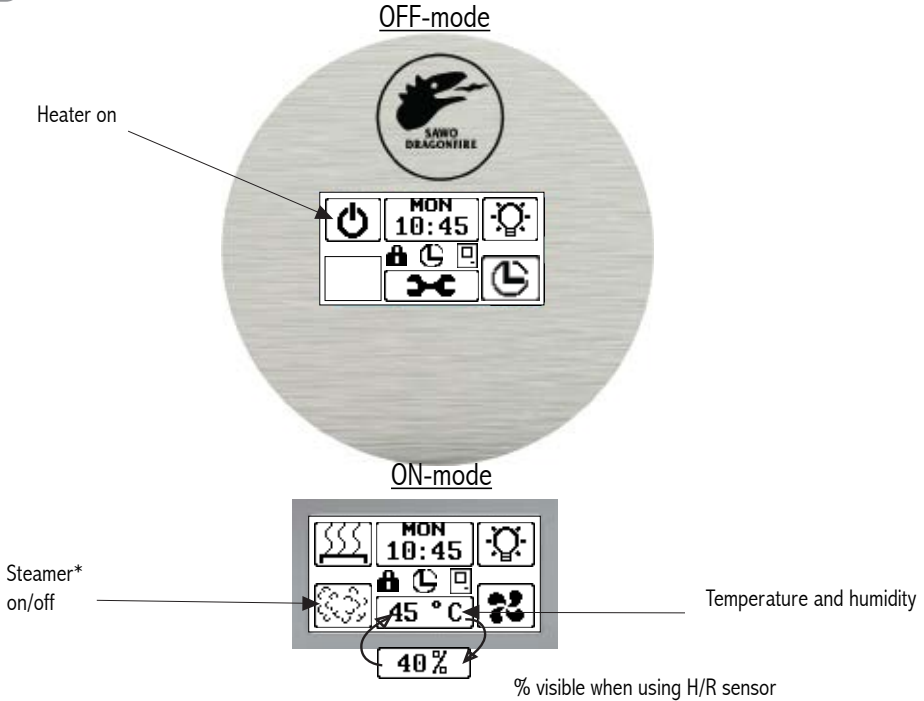

1. The heater can be switched on by pressing the heater on icon in OFF mode.
2. Alternatively, the user can switch the steamer on by pressing the steamer icon in the ON mode. Those features that have animated logo are currently active. If you want to turn on/off the steamer*, press the steamer icon.
3. Heater and steamer are turned off by pressing the heater-icon. After this Dragonfire will automatically go to off-mode.



WARNING

Always check that there are no combustible materials, like towels, above the heater, nor inside the safety distances, before switching the heater on! The safety distances are stated in the heater manual.

Once the heater has been switched on, ON mode will be displayed. The user can change the settings simply by pressing the relevant icon on the display and using the up and down arrows.



Up and Down Arrow Keys

The Up and Down Arrow Keys are repetitive. This means that holding down the up or down key will cause the set-point value to increase or decrease with a specific rate. This rate also increases when holding the key for a longer time.

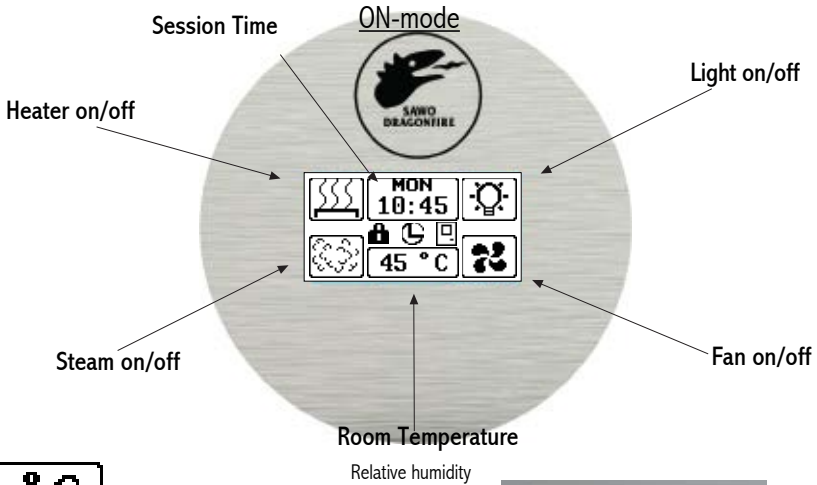

45 °C 2.2.1 Temperature

Press the temperature icon to change the temperature with up and down arrow keys. After setting the preferred temperature, user can go back to the previous state with saved settings by pressing the OK button.

If no keys are pressed within 5 seconds after pressing the temperature button, the changes are saved and control will go back to previous state.

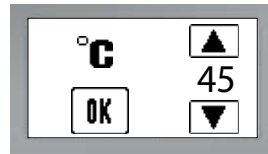

Temperature Unit = Celcius

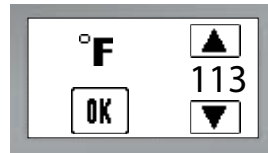

Temperature Unit = Fahrenheit

RH% 2.2.2 Relative Humidity

To change the relative humidity (not in all models), press the humidity icon and use the up and down arrow keys to change it. After setting the preferred humidity, user can go back to the previous menu with saved settings by pressing the enter button.

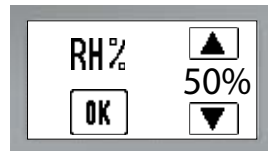

If no keys are pressed within 5 seconds after pressing the temperature button, the changes are saved and control will go back to previous state.

MON
10:45

2.2.3 Session Time

Press the session time icon to change it with up and down arrow keys. After setting the preferred session time, user can go back to the previous menu with saved settings by pressing the enter button.

If no keys are pressed within 5 seconds after pressing the session time button, the changes will be saved control returns back to previous state.

If the session time is changed within the first 5 minutes after starting, the set values are saved as a start value for the next session.



When the session time expires, a high tone buzzer notifies the user. Then the control unit goes to off mode or cabin drying (only with steamer).

The session can be finished earlier than originally set by pressing the heater on/off button.

The control unit goes to off mode or cabin drying (only with steamer).

If the user attempts to put an invalid input, short, low tone buzzer can be heard to alarm the user.



FAN
OFF



FAN
ON

2.2.4 Fan

Press the fan icon (not in all models), to set the fan speed, in the range of 5% - 100%. After setting the preferred speed, user can go back to the previous menu with saved settings by waiting for 5 seconds to automatically return or pressing the OK button to return immediately.

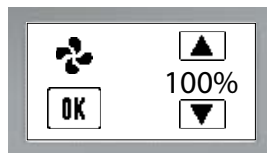

When fan is on, the icon is animated. By pressing the fan icon again the fan will stop and the animation of the icon stops.



2.2.5 Sauna Session

When the heater is on, the sauna icon is animated. You can turn off the heater by pressing the sauna icon. After pressing control will go to off mode/cabin dry mode.



2.2.6 Steamer Session (available in combi models)

When steam session is activated, the steamer symbol is animated. If user presses again the animated steamer symbol, steamer is turned off and the

session will continue as a normal sauna session.



2.3 Switching the Control Unit ON/OFF

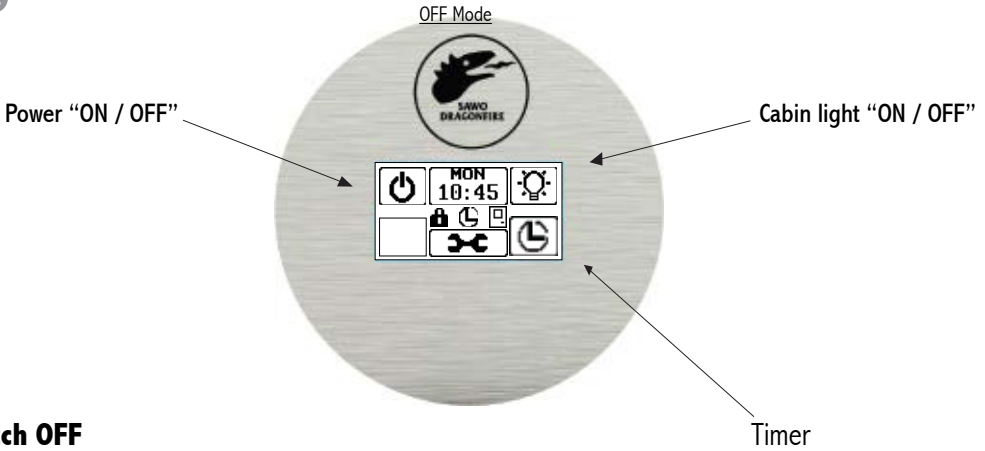

Switch OFF

The backlight is turned off after 1 minute of inactivity (no key pressed). after 60 minutes of inactivity (no key pressed) and no pending drain, autofan or active autosession display will turn off.

2.3.1 Cabin Light

Cabin lights can be switched on and off by pressing Cabin Light button even when the control unit is in OFF-state. If dimmer feature is available, you can adjust the brightness with arrow buttons. Confirm any changes by pressing OK-button. If no buttons are pressed in five seconds, any changes will be saved and display returns to it's previous state.

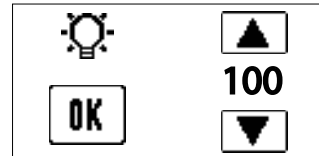



2.4 Pre-run Timer

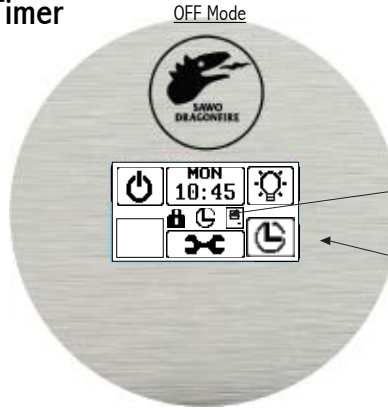

When small timer icon appears, there is 1 or more active timer settings at the moment
Timer

2.4.1 Settings



2.4.2 Pre-run Timer

The Dragonfire Touch control unit has a weekly timer that can be programmed for every day of the week.

This feature is only available for public saunas, used in condominiums, hotels or other similar places.

2.4.3 Pre-run Timer for Domestic Saunas

For domestic sauna use, the weekly timer is not allowed*). Only one pre-run timer setting can be made at a time. The pre-run time is limited to a maximum of 6 hours for domestic saunas.

*) IEC 60335-2-53

After pressing the timer icon in the OFF-mode, the following screens will be shown displaying existing pre-run settings.

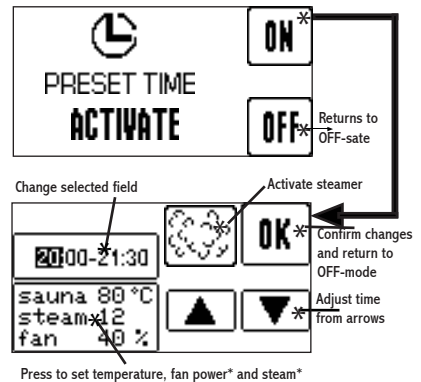

Press to set temperature, fan power* and steam*



Press timer icon to enter the preset timer settings.



To change any preset timer settings, move on to next screen by pressing ON-button. Turn off any timer settings by pressing OFF-button and return to OFF-mode.



WARNING

Always check that there are no combustible materials, like towels, above the heater, nor inside the safety distances, before switching the heater or pre-run timer on! The safety distances are stated in the heater manual.



NOTE

By Default, the Pre-run Timer is set for Domestic Sauna use.

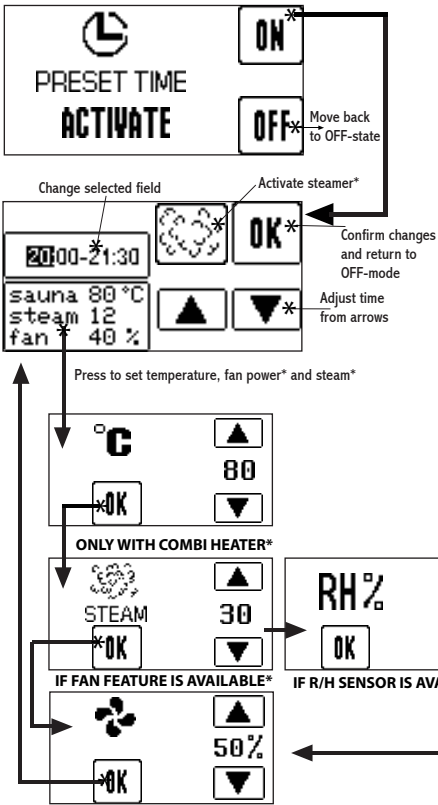

By pressing OFF-button you can cancel all active timers and go back to OFF-mode. By pressing ON-button you will move on to changing timer settings. Cancel all active timers by pressing the OFF button.

You can activate steamer by pressing the steamer icon. By pressing time you can move the cursor from hours to minutes and change the time value from arrow buttons. To adjust temperature, steamer* or fan*, press the "sauna" text. Adjust values as preferred and move to next screen by pressing OK or waiting 5 seconds. Confirm changes and save the timer by pressing OK and return to OFF-mode.

*Available settings may vary between models

When adjustments to time and settings are done, save timer by pressing OK button.

If small timer icon is visible, it means that there is an active timer setting at the moment.

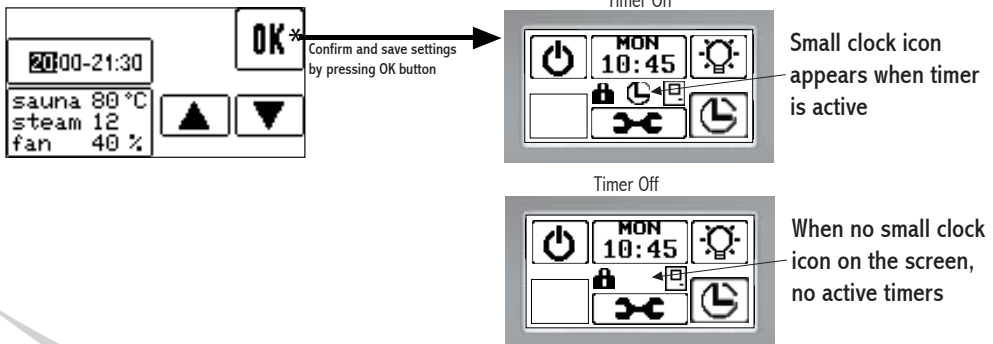

2.4.4 Pre-run timer for public saunas with weekly timer

OFF-mode

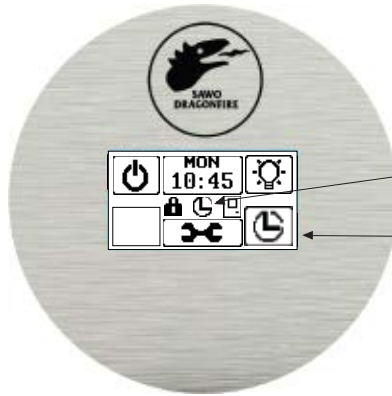

When small timer icon is visible, there is active timers at the moment

Timer



Press timer icon to set timers



Then you can continue to adjust timer settings by pressing OK. If you want to return back to OFF mode and turn off all timers press OFF button.

Weekly timer is only available if max session time setting has adjusted to be 12 hours or more (page 22). If max on time has been set to 12 hours, automatic restart can only happen after 6 hours of the previous automatic start (IEC 6-335-253).



NOTE

Before setting any preset timers, make sure that current day and time are correct from the settings menu (2.5).

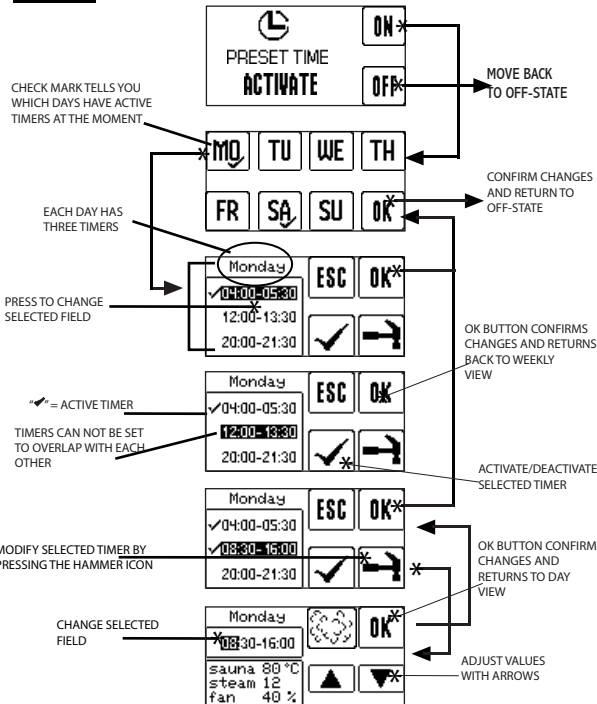

After pressing ON button you will go to adjust timer settings. Days that have "✓" indicator have an active timer. By long pressing that days icon for 3 seconds you can cancel all active timers from that particular day. By pressing on any of the week days you can adjust the timer settings of that day.

Press the timers to change selected field. Timers that have "✓" indicator are currently active. Activate/inactivate timer by pressing the ✓-button

Press the hammer icon to change settings of the selected timer. By pressing ESC button you can cancel any changes and return to OFF mode.

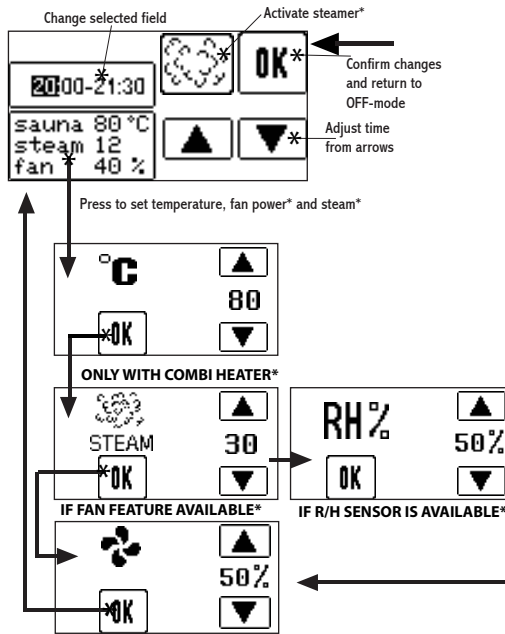

You can activate steamer by pressing the steamer icon. By pressing time you can move the cursor from hours to minutes and change the time value from arrow buttons. To adjust temperature, steamer* or fan*, press the "sauna" text. Adjust values as preferred and move to next screen by pressing OK or waiting 5 seconds. Confirm changes and save the timer by pressing OK and return to OFF-mode.

*Available settings may vary between models

After changing setting you can confirm changes by pressing OK button and return to daily view --> weekly view --> Off mode.

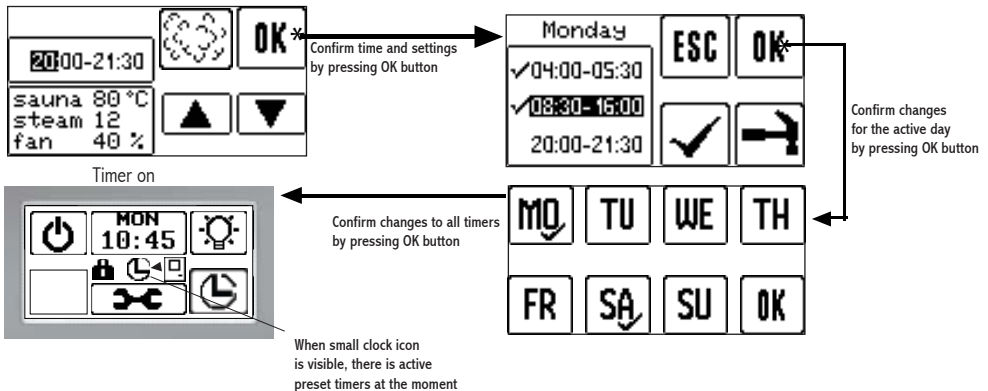



2.5 Changing the settings

From OFF mode you can access to settings, timer, Easy mode and turn on lights and heater

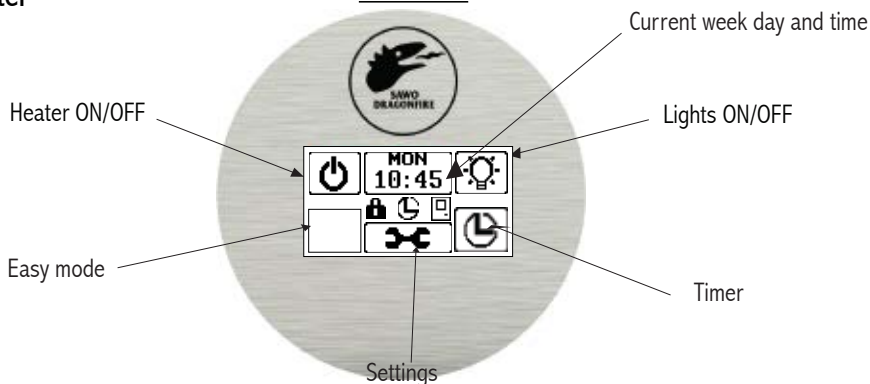

Long press settings button for 5 seconds to access settings menu. In settings menu you can navigate between settings by using arrows Right and Left, and change the displayed setting by using arrows Up and Down unless mentioned otherwise below. After changes are done confirm them by navigating to Save&Exit screen and press SAVE. If you want to discard all changes press ESC.



1. Pressing the weekday, hours or minutes button you can set the correct time and day. In case of electricity blackout the day and time keep running and there is no need to set them again.

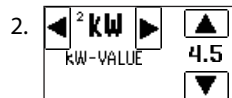

2. Check what is the power of your heater and adjust the value on screen accordingly in kilowatts.



3. When auto cabin light is activated, the lights will turn on automatically when the heater is turned on. If this function is disabled you can use the cabin light manually.



4. Auto fan feature is for drying your sauna room after sauna session. You can adjust the desired exhaust fan time. Fan will turn on automatically after sauna session has ended.



5. You can adjust the LCD contrast.



6. Active blackout memory restores control to its previous state before power failure. For example, if heater was on before power failure, the heater will automatically continue from the previous state.

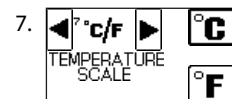

7. You may set the temperature scale either Celsius or Fahrenheit.



8. Software version has two parts, Interface Software Version and the Controller Board Version.

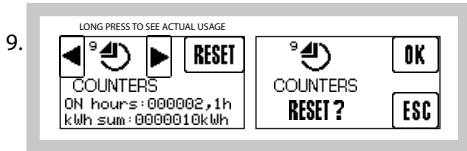

Counters displays the usage of time and kilowatt of the heater/steamer. This info is necessary to evaluate need of preventive maintenance and compute electricity consumption. Pressing reset button will reset both counters, previous data cant be retrieved. Long pressing reset button for 10 seconds to see actual usage. Actual usage counter can not be reseted.

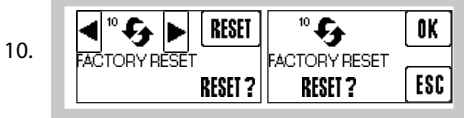

Reset all settings back to factory settings by pressing reset button. Confirm resetting by pressing OK button. Restoring factory settings wont reset kWh and ON hours counters.

Only in Combi heater

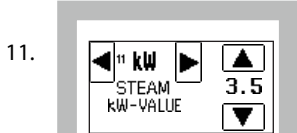

11. Set the correct kilowatt value of the Combi steamer to the control(see kilowatt information on your steamer). Change the value with arrows.



Cabin dry setting will help you to dry up your sauna room after a steam session. After steam session the display will automatically start cabin dry. During cabin dry the set value for room temperature is 70 C and fan power 100%. Cabin drying takes 30 minutes. You can cancel on going drying by pressing ESC button. NOTE: if cabin dry is enabled, max on time for steam session is reduced by 30 minutes if max on time is set to 4, 6 or 12 hours.

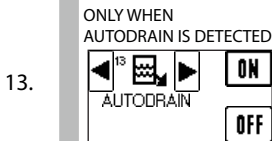

13. When auto drain is enabled, it will automatically drain the water inside the combi tank after use. In case of power interruption, it will continue to drain when detecting high water level in the tank. If there is draining pending, this icon will be shown on the screen:



14. Once everything has been set, you may press SAVE to save all the changes, or by pressing ESC to discard all changes.



2.6 Other Dragonfire contorl features



2.6.2 Key lock

To lock/unlock screen, press more than 10 seconds the settings icon. Lock will appear on the screen when key lock is activated:  When key lock is activated, you can still turn the heater ON/OFF and use the cabin lights. If any unauthorised actions are made, "KEY LOCK" text will appear on the screen for 5 seconds.

When power controller is turned ON again, the Key Lock will remain either ON or OFF as it was before power controller was turned OFF.

Technical Diagram

Fig. 1

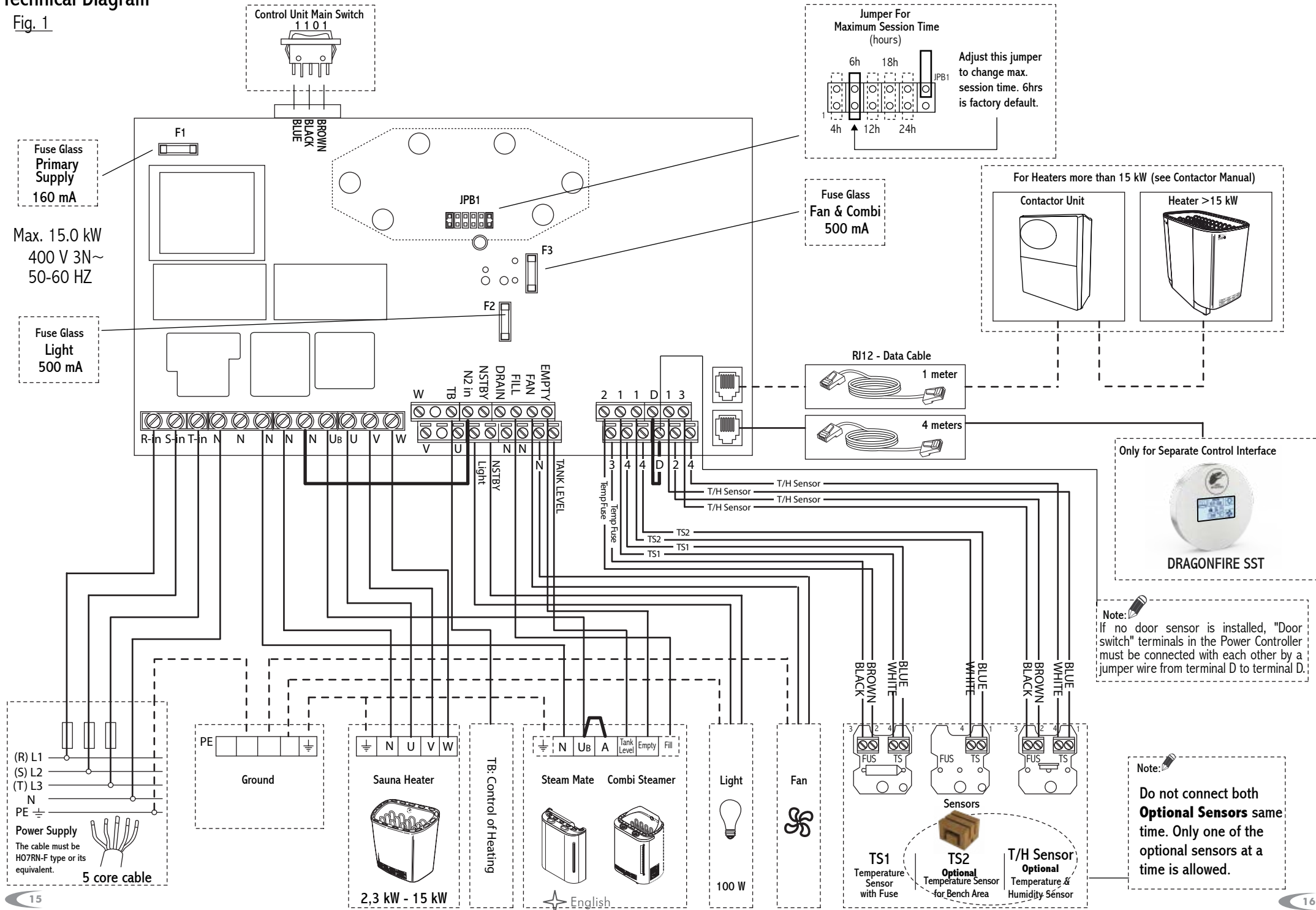

2.7 Combi Features

2.7.1 Steamer

These features for steamer are only applicable with Combi heaters.

2.7.2 Humidity & Temperature in the Sauna

High humidity and high temperature are not allowed simultaneously in the sauna room. When sauna session is switched to steamer session, sensors will check that the temperature or the relative humidity inside the sauna room is not too high.

If the temperature or relative humidity is too high, the steamer will not be activated.

Steamer activation depends on the second sensor, the bench sensor. If it is a temperature sensor only, and the bench temperature in the sauna room is 56°C or more, the steamer cannot be activated. The user can

choose the relative time for the steamer to be on, within 30-100% of the session time.

However, if the second sensor is combined temperature / humidity sensor, the maximum bench temperature for the steamer to activate is 80°C, as long as the relative humidity in the sauna room is not too high. With the combined sensor, the user can choose the relative humidity inside the sauna room.

2.7.3 Cabin Drying



The standard drying time is set for 30 minutes at 70°C. If the fan is connected with the control unit, it will be running at 100%, during the cabin drying. The cabin drying is set to begin 10 minutes after the steamer session. Therefore, the actual drying time is 20 minutes.



If during the steamer session the operation mode is changed to heater only, there will be no drying time at the end of the session. You can abort cabin drying by pressing the ESC button.

2.4 Water Refill

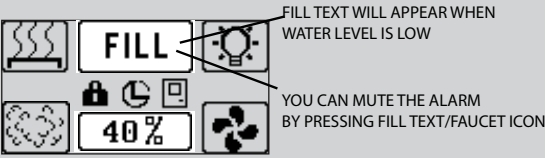

When the water level is low, a low tone interval beep and “Fill” will be displayed to alarm the user.

The water tank can be filled manually or automatically (autofill) depending on the steamer model.

The auto Combi heater has a solenoid valve, which will automatically react to the low level of water. The water inlet will open to fill up the tank and steamer session can be continued without intervention.

In the manual fill, the alarm beeps and “Fill”

will be displayed as long as the user fills the tank. If the water tank dries, a high tone interval beep and “Dry” display will alarm the user. In the display a faucet icon and “Fill” text will be alternating each second.

The steamer will automatically be switched off now, only the heater will be working.

Always check that the water supply is open before using the automatic refill Combi heater!

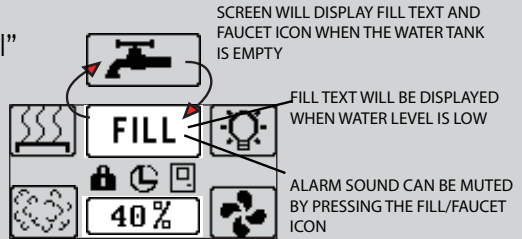

3. Remote and Alarm Connections

(Back of the user's panel)

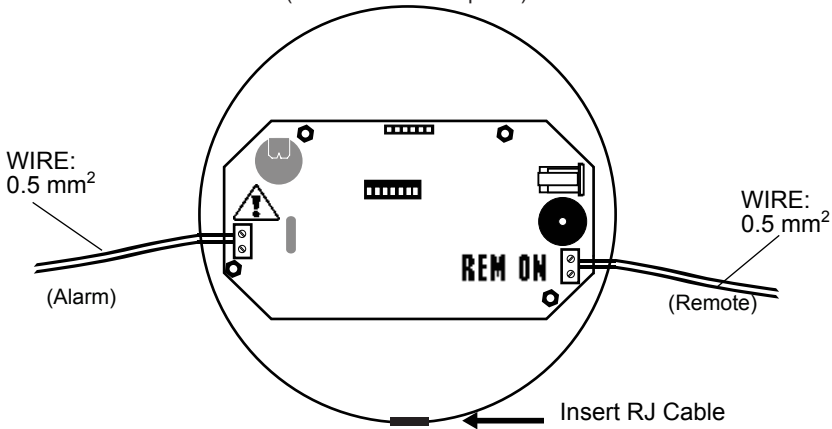

3.1 Emergency Alarm



The steam generator control has a provision for emergency alarm system. Alarm button must have potential free momentary or latching contacts.

Long press OK button if alarm has been settled.

3.2 Remote On

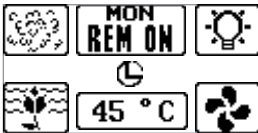

Used for automated households. The remote signal is a potential free contact. The steam generator switches on when contact is closed and remains on until contact is opened.

When the steam generator is remotely controlled, settings used from previous session are applied. Other buttons are locked. Only the Light, Fan and Aroma buttons can be set.

4. Assembly and Installation

The Dragonfire Control Unit consists of the Touch Control panel (Separate or Built-in), Power Controller and Sensors. The control panel and Power Controller communicate by using a RJ12 cable.

4.1 Control Unit to Heater Connection Diagram



WARNING

If door sensor is used and sauna door is opened during pre run time, all preset timers are inactivated. While door is open, door icon is displayed. 

Fig.2



4.2 Power Controller

The power controller or the separate control panel must not be located inside the sauna room or in places where temperature can exceed +40°C. It is protected against water splashes, however it should not get in contact with water. Mount the controller board on a dry location, outside the sauna room.

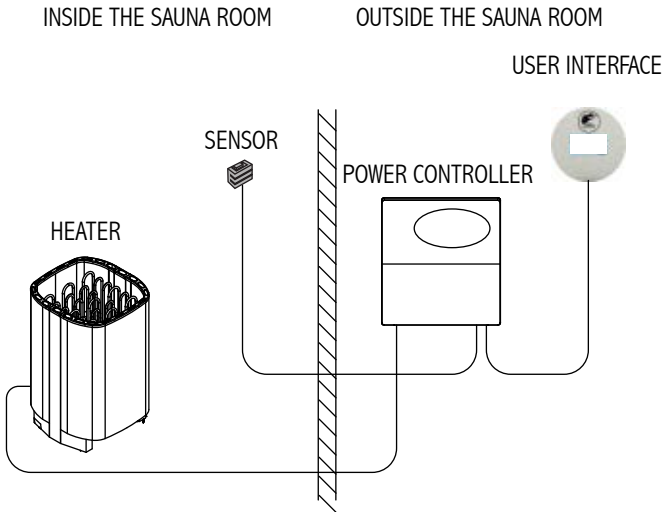
Install the Power Controller Board on the wall in vertical direction only and at least 30cm from the ceiling (refer to Fig.3).

The heater is connected to the electrical network semi-stationarily with a H07RN-F rubber cable or its equivalent. The use of PVC-insulated cable as a connecting cable is prohibited due to thermal embrittlement. The maximum distance of the junction box from the floor is 400 mm, measured from the upper corner of the box.

Fig.3

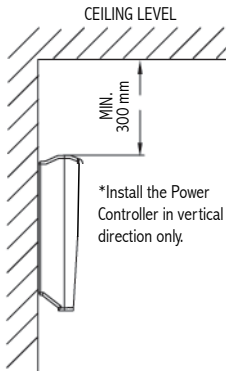
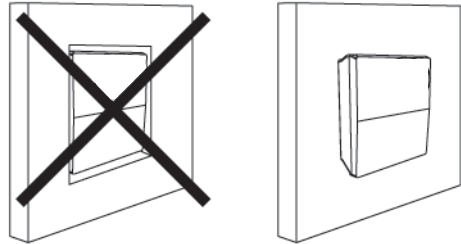

Fig.4



Do not embed the control unit into the wall, because it may lead to overheating of the unit and cause damage!

4.3 Contactor Unit

If the heater used is more than 15kW, an additional contactor is needed. The contactor unit is linked to the main Power Controller Board with a RJ12 cable (Fig.5).

Follow the instructions that are supplied together with the contactor unit.

Fig.5

Installation of separate Control Panel and Power Controller with Contactor Unit

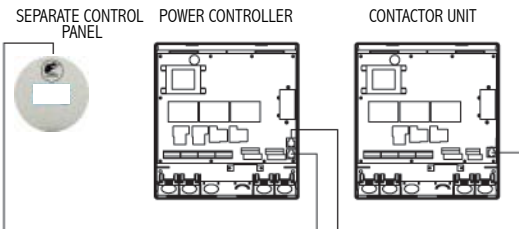

4.4 Sensors

One or two sensors can be connected to the Power Controller. The first sensor measures the temperature, it is the sensor with temperature fuse and thermistor.

The second sensor, the optional bench sensor, is a temperature sensor or combined temperature humidity sensor. The combined sensor is capable of measuring the humidity as well as the temperature.

With two sensors it is possible to receive more accurate measurements from the sauna room.

If the heater is mounted on the wall or floor standing less than 200mm from the wall, the first temperature sensor needs to be mounted on the wall above the heater. Place the sensor 150mm from the ceiling (Fig. 6 & 7).

However, if the heater is more than 200mm from the wall, place the sensor to the ceiling, over the heater, as shown in the figure 8 & 9.

The optional second sensor should be mounted on the wall, opposite to the heater, minimum 30cm from the ceiling and minimum 130cm from the floor (fig 6 & 8). It is designed to measure the bench temperature, so ideally place it close to the shoulder height of the sauna goers.

Do not place the sensors near the air ventilation. The closeness of the air vent cools down the sensor. Thus, an incorrect temperature is displayed and the heater may overheat (Fig.9).



NOTE

Do not place the sensors too near to air ventilation (not under 1000mm from non directed) or not under 500mm from air ventilation, which is directed away from sensors.

4.4.1 Sensor location with heaters mounted on the wall

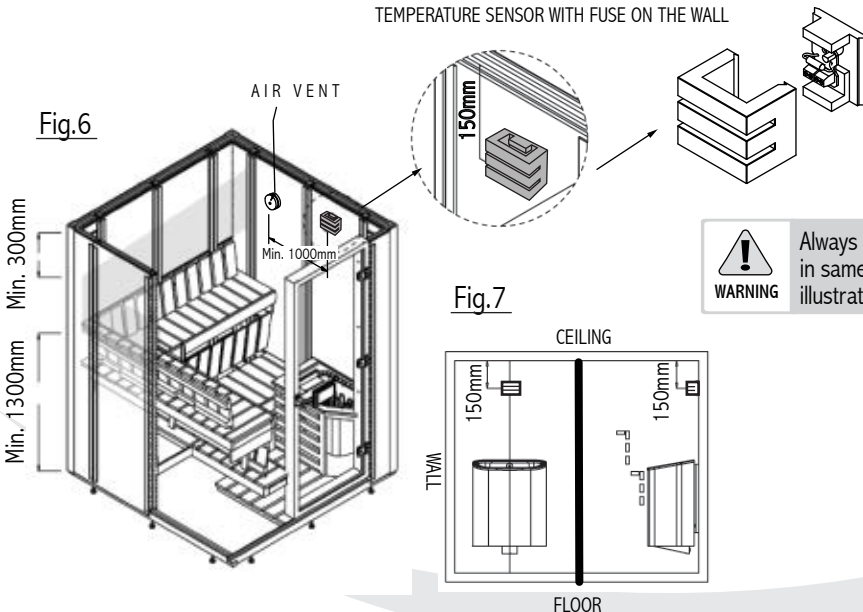

4.4.2 Sensor location with heaters mounted on the floor more than 200mm from the wall

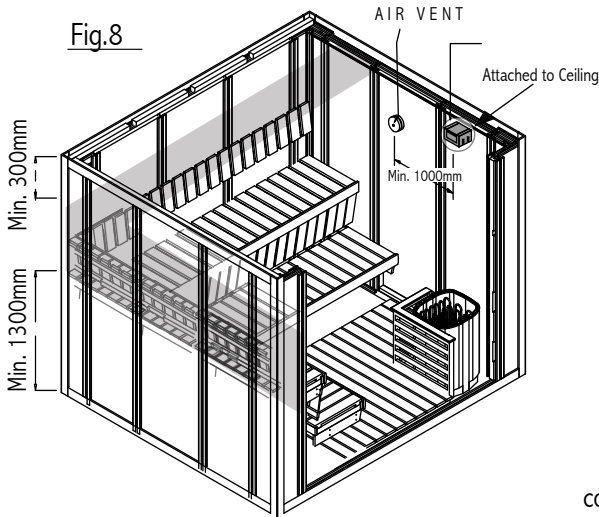
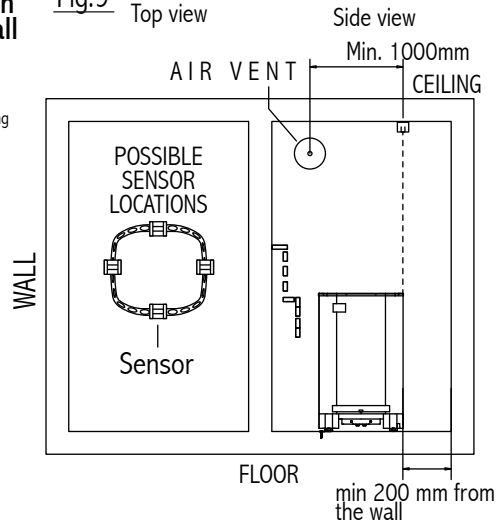

Fig.9 Top view



4.5 Maximum Session Time

The maximum sauna session time depends on the purpose of the sauna. For domestic use, the total on-time of the sauna is limited to 6 hours. It includes pre-run time and the session time. The factory setting for the control unit is 6 hours.

For condominiums, hotels and similar locations, the operating period of the sauna heater is limited to 12 hours, including the pre-run time and the session time. For public sauna, the operating period of the sauna heater can be either 18 or 24 hours. Please note, if the public sauna is set to 24 hours, it will be on constantly. It needs to be continuously attended.

condominiums and other public saunas. If the maximum session time is set to 12 hours and weekly timer is used, the heater must have a minimum 6 hours of inactivity in between sessions (IEC 60335-2-53).

The maximum heater on-time is set by the jumpers on SCB1 in the power controller, see the picture 1 & 10. In Finland jumpers 3, 4 and 5 are meant only for public sauna rooms. Only a qualified electrical can change the settings. The standards and regulations of the country where the control unit is installed must be followed, when setting the jumpers. When no jumpers are placed, the default time is 6 hours. See the Table 1.

The weekly timer is only allowed for hotels,



If you need to change the settings in the power controller with built-in panel, removing the panel board helps.

Fig.10

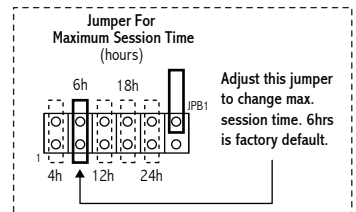

Table 1

Sauna Type	Domestic sauna		Hotels, Condominiums	Public sauna	
Jumper	1	2	3	4	5
Max. time	4h	6h	12h	18h	24h
Max. pre-run time	2h - steam	4h - steam	weekly timer		
	3h - steam	5h - steam			

4.6 Door Sensor (Optional)

In other than household use, it is recommended to install door sensor. The door sensor disables all pre-run operations if the door is opened while the pre-run count-down is active.

The door sensor also ensures that the door is not open for long periods of time when the heater is on. If the heater is on and the door is open for more than 15 minutes, an alarm and "DOOR" will be displayed to warn the user. The heater will be switched off automatically.

Note!



If door sensor is not installed, "Door switch" terminals (D-D) must be connected with each other by a jumper wire. See figure 1. Note, connection is not present in the drawing.

4.7 Fan (Optional)

The fan function can only be activated if the fan feature is present on the control unit. Ensure that the fan motor to be controlled is either shaded pole or permanent split capacitor motor. The maximum power is 100W with 230 VAC.

4.8 Dimmer (Optional)

It is possible to use any suitable lamp of your choice in the sauna room. However, if the dimmer feature is present on the control unit and wished to be used, only incandescent lamp is suitable.

4.9 Installation for power controller with built in control panel (See Illustration)

Follow the steps in the illustration below. Before installation, please read first chapter 1.1 Precautions.

1. Install Power Controller outside sauna room in a dry place, where temperature will not exceed +40C and condense of water is not possible inside the controller.
2. Unscrew two screws from the top cover.
3. Remove the plastic cover of the unit by pushing the front lock through the hole in the chassis.
4. Insert the designated wires to corresponding terminals. See Diagram.
5. Drill holes for the screws on the wall to attach the power controller. Install the power controller in vertical direction only. Follow the measurements given.
6. Cover back the power controller after the wiring connections have been made by snapping the front lock. Screw the two screws back to the top cover.

Fig.11

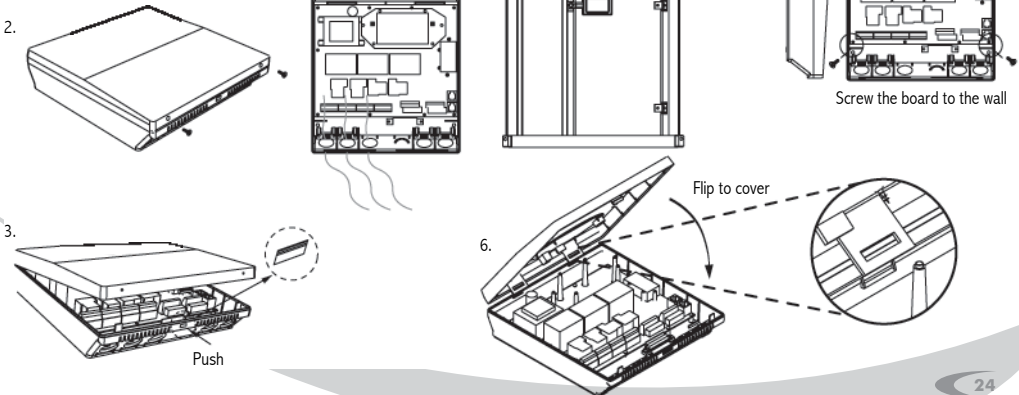

4.10 Installation for Separate Control Panel (See Illustration)

1. Mount the Separate control panel casing outside the sauna room, in preferred, secure area on a room temperature.
2. Connect the RJ12 cable provided from the control panel to the Power Controller.
3. Attach the casing on the Control panel to the wall on the holes provided.
4. Place the top cover of the panel to the mounted frame.

Fig.12

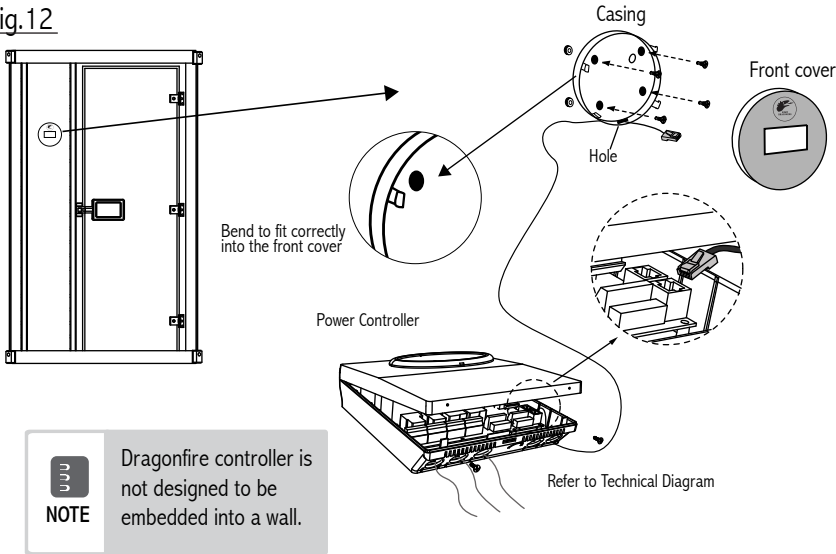

4.11 The Control Unit Main Switch

The control unit switch can be found on the top end of the unit. Using this switch, you can isolate the electronics from the mains power supply.

In order to put the unit into operation, switch to the first position (switch position I). In this switch position all control unit's functions work normally.

In case of breakdown, press the control unit switch on the left part of the rocker to the middle position (switch position 0). The unit is now completely switched off.

In order to switch on the light in the sauna when the unit is switched off, press on the left part of the rocker to the second position (switch position II).

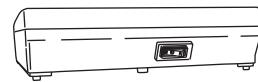

II 0 I

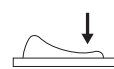

I = UNIT ON



0 = OFF

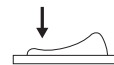

II = LIGHT ON

5. Troubleshooting

If an error occurs, the heater will be switched off. There will be a high tone warning beep for 2 seconds. Text "ERROR" will be blinking in the display with the error description. See more details on the table below.

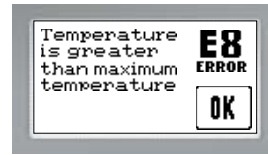

Please note, only a qualified electrical or maintenance personnel should make the service operations or repairs.

Table 2

Code	Problem	Solution
E1	Temperature sensor 1 is not connected.	Check the wire between the sensor and the control unit. If there is no problem with the wires and they are correctly installed, check the sensor. If no reason for the problem can be found, contact the retailer.
E2	Temperature sensor 1 is short circuit.	
E3	Temperature fuse has blown.	Check the wire between the sensor and the control unit. It has probably overheated. The reason for it needs to be discovered before using the sauna again. A new sensor is needed. If no reason for the problem can be found, contact the retailer.
E4	Temperature sensor 2 is not connected.	Check the wire between the sensor and the control unit. If there is no problem with the wires and they are correctly installed, check the sensor. The heater can still be used with the sensor 1 only, but 2 sensors are needed for the steamer. If a new sensor needed or no reason for the problem can be found, contact the retailer.
E5	Temperature sensor 2 is short circuit.	
E6	Combined Temperature / Humidity sensor is defective.	
E7	Communication failure.	Check the RJ12 cable. If the area where the cable is located has many other cables, it can cause interference problems. If built-in model is used, remove the control panel. Wipe the pin header contact to remove any dirt. Assemble back the control panel in correct position and make sure the six pin header connectors are properly inserted to the socket. If no reason for the problem can be found, contact the retailer.
E8	Temperature is greater than the maximum temperature.	Contact qualified electrician or maintenance personnel before using the sauna again.

Other possible problems are:

- The control unit is working fine, but the heater does not turn on. Check the electricity supply to the heater. Check that the wires for the sensors are placed into the correct terminals in the power controller.
- The control unit cannot display the relative humidity (only when the combined sensor is installed). The combined sensor cannot be recognised. The wires for the sensor are placed in the wrong terminals.
- Control unit does not turn on. Check that:
 - Main switch of control unit is in position 1 (Unit On). Two illuminated dots on display indicate that power is on.
 - N2in is connected with the N with a wire jumper.
 - Fuse F1 (near transformer) is tightly in fuse holder.
- If error E4 or E6 is displayed, there is a problem with the bench sensor. If only one sensor is installed, the steamer cannot be used. The user can confirm the error by pressing the on/off button, after which the heater will function normally, but the steamer cannot be used.
- The user switches the steamer on and “dry” is displayed immediately. Check that the “empty” and “tank level” terminals from the heater are connected with the “empty” and the “tank level” in the power controller.
- The steamer is on and “dry” is displayed, even though there is plenty of water in the tank. Make sure that terminals “empty” and “tank level” are correctly connected to the right terminals in the power controller.
- The steamer is switched on and “dry” is displayed immediately. Make sure that the “WB” terminal from the heater is connected to the “tank level” in the power controller. Check that the “UB” terminal from the controller is connected with the “empty” terminal on the controller.
- When the user turns the steamer on and “Fill” is displayed continuously, the wiring needs to be checked. Make sure that the “UB” terminal from the controller is connected to the “empty” terminal in the power controller. In addition, the “WB” terminal from the heater needs to be connected to the “tank level” in the power controller.
- Door open symbol is displayed with high warning tone, when door sensor is not installed. - Check that door switch terminals are connected with each other by wire in the power controller. (See fig. 2/Sensors. Note that the connections is not present in the drawing



















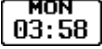

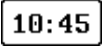

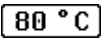

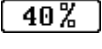

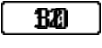
6. Symbol Reference

	Short press	To switch on – Manual Sauna session
	Long press and no pending drain, autofan or active autosession	Switch display off
	Date and time	Change date and time from settings
	Short press	Light on/off
	Short press (if dimmer feature available)	set Cabine Light brightness
	Press > 10 seconds	Activate EasyMode
	5 sec press	Go to settings
	10 sec press	Activate key lock
	If auto fan active	Icon animated
	When auto fan is not active	Change timer settings
	Key lock activated	
	Timer is active	Icon visible if there are any active timer settings
	Sauna door is open	If door open and pending for auto drain, icons will blink on the screen with 3 sec interwall
	Pending for steamer auto drain	





ON-mode

	Short press	Sauna/steam session off
Icon animated if feature active		
	Remote control on	
	Session time	Press to change session time
	Combi heater's water tank needs to refill	Beeping sound will stop when icon is pressed
	Combi heater's water tank is empty	Beeping sound will stop when icon is pressed
	Short press	Light on/off
	Short press (if dimmer feature available)	set Cabine Light brightness
Icon animated if feature active		
	Short press	Steamer on
	Short press	Adjust temperature, relative humidity and steamer. Features are depending of heater model and sensor types.
	Short press	Fan on/off
	Icon animated if feature active	
		Set fan speed

Buttons

ANIMATED		Heater ON 1		Selector UP
ANIMATED		Steam ON 1		Selector DOWN
ANIMATED		Light 1 / Light OFF		Selector LEFT
ANIMATED		Fan1 / Fan OFF		Selector RIGHT
		Day & Session Time		ON
		Session Time		OFF
		Room Tempeture		Celcius
		Humidity		Fahrenheit
		Steam Strength		Preset Day
		ON/OFF Button		Preset Selected Day
		Settings Menu		Reset
		Save		Time Setting
		Confirm OK		Time Group Activate
		Escape		

Indicators

	Key Lock		Autodrain	E1 ERROR	Error 1	Temperature sensor 1 not connected.
	Preset time activated	AUTODRAIN		E2 ERROR	Error 2	Temperature sensor 1 short circuit.
	Door Lock		Save and Exit	E3 ERROR	Error 3	Temperature fuse has blown.
	Preset Time	SAVE & EXIT		E4 ERROR	Error 4	Temperature sensor 2 is not connected.
PRESET TIME			Steam Generator is remotely controlled	E5 ERROR	Error 5	Temperature sensor 2 short circuit.
ACTIVATE	Activate		Control Alarm	E6 ERROR	Error 6	Combined Temp/Hum sensor is defective.
¹ 	Day and Time		Cabin Dry	E7 ERROR	Error 7	Communication Failure.
DAY / TIME			Low Water Level Combi Tank (Alternate)	E8 ERROR	Error 8	Temperature is greater than maximum temperature
	Day		Low Water Level Combi Tank			
	Hours		Cabin Drying Time Counter			
	Minutes		Draining			
² kW	Kilowatt Indicator	09:55	Drain Time Counter			
kW-VALUE			Draining			
kW	Steamer Kilowatt Indicator	09:55	Drain Time Counter			
STEAM kW-VALUE						
³ 	Auto Light ON					
AUTO						
⁴ 	Auto Fan					
AUTO						
⁵ 	LCD Contrast					
LCD CONTRAST						
⁶ 	Blackout Memory					
BLACKOUT MEMORY						
⁷ °C/F	Temperature Unit					
TEMPERATURE SCALE						
⁸ 	Software Version Info					
SW-VERSION						
⁹ 	Usage Counter					
COUNTERS						
	Preset timer active					
¹⁰ 	Factory Reset					
FACTORY RESET						

Description	Power Rating	Remarks
Control		
Rated Power 3 Phases	15kW AC1 (3 x 5kW)	
Rated Voltage 3 Phases	400V 3N~	
Rated Power Single Phase	9kW AC1	
Rated Voltage Single Phase	230V 1N~	
Frequency	50/60Hz	
Switching capacity per phase	21A	
Sauna temperature range	40-110°C	
Maximum session time (preset)	4,6, 12, 18, 24h	Restrictions apply according to IEC/EN 60335-2-53
Dimensions		
User Interface	(L) 145mm (W) 145mm (H) 26mm	
Power Controller	(W) 265 x (H) 245 x (D) 75	
Weight		
User Interface	558g	
Power Controller	1500g	
Sensor		
Temperature Sensor with fuse		
Bench Sensors		
Bench Temperature Sensor		Optional
Bench Combined Temperature - Humidity Sensor		Optional

Description	Power Rating	Remarks
Steamer		
Rated Power 3 Phases	5kW AC1	
Rated Power Single Phase	3kW AC1	
Rated Voltage	230V 1N~	
Switching capacity	21A (3 Phases), 13A (1 Phase)	
Maximum sauna temperature for steamer operation	80°C or *55°C * Depending on the type of Sensor 2.	
Automatic water filling		Optional
Automatic drain valve		Optional
Cabin Light		
Rating	230V 1N~, 100W AC1	Min 20W, max 100W. Only resistive load or dimmable (phase control compatible) light bulb
		Dimmer optional
Fan		
Rating	230V 1N~, 0,5A	Fan without starting capacitor. Optional (with speed control)
Fuse		
Fuse F1	(160mA) is fuse for electronics	
Fuse F2	(1A slow) is fuse for cabin light,	
Fuse F3	(500mA slow) is fuse for fan and automatic refilling combi .	
Power Extension Unit		
Rated Power 3 Phases	15kW AC1 (3 x 5kW)	Additional Power expansion to maximum of 30kW
Rated Voltage 3 Phases	400V 3N~	
Frequency	50/60Hz	
Switching capacity per phase	21A	

Note!

Only incandescent light bulbs are allowed to use with Dragonfire sauna controller. Light fixtures using electronic transformers for example LED lights, compact fluorescent lights and other similar lights are not compatible with Dragonfire sauna controller. Damages caused by connecting these non-compatible lights are not covered by warranty.



www.sawo.com
info@sawo.com

Subject to change without notice.



DRF_SST_ML_S_En0916