

Mythos S34 / S45

sauna heater

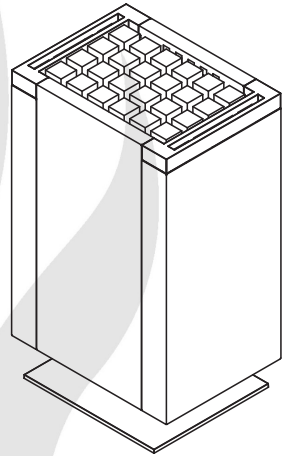

GB Installation and operation manual

MADE IN GERMANY



Image above shows optional equipment.

print no. 29344483en / 05.13



English

Contents

| | |
|--|----|
| Intended use..... | 3 |
| General notes..... | 3 |
| Important notes | 4 |
| Electrical connection | |
| Example of connections for Mythos S35 and S45..... | 6 |
| Example of connections for Mythos S35 Vapor and S45 Vapor | 7 |
| Installation | |
| Scope of delivery | 8 |
| Specifications | 8 |
| Minimum clearances..... | 8 |
| Heater foot sealing installation..... | 9 |
| Cable connections | 9 |
| Installation of „Cubic“ stones | 9 |
| Dry Finnish sauna operation..... | 10 |
| Sauna rocks..... | 11 |
| Maintenance and care | 11 |
| Special installation advice | 12 |
| Service address..... | 13 |
| Recycling..... | 13 |
| Guarantee..... | 13 |
| Handling procedures for return shipments (RMA) - Details for all returns ! | 14 |

Dear customer

You have purchased a high-quality technical device with which you will have years of sauna fun. This sauna heater was designed and inspected according to the current European safety standards and manufactured at the factory in accordance with the quality management standard DIN EN ISO 9001:2000.

This detailed installation and operation manual has been prepared for your information. Please observe in particular the **important notes** and the information on electrical connection.

We wish you exhilarating recreational experience and lots of fun with your sauna!

Appropriate use

This sauna heater is exclusively intended for heating sauna cabins in combination with an appropriate control unit.

Any other use over and above the intended purpose is not considered as appropriate use! Compliance of the standard operation, maintenance and repair conditions is also an element of appropriate use.

The manufacturer cannot be held liable for deviating, unauthorized alterations and any resulting damages: the initiator of these changes bears the full risk.

General information

Please check whether the unit has arrived in perfect condition. Any transport damages should be immediately reported to the freight forwarder delivering the goods or you should contact the company that shipped the goods.

Please note that you will only be able to achieve an optimum sauna climate if the cabin with its air intake and ventilation, the sauna heater and the control unit are aligned to each other.





Please observe the information and stipulations made by your sauna supplier.

Sauna heaters heat up your sauna cabin using heated convective air. Here, fresh air is drawn in from the air intake which, when heated, rises upwards (convection) and is then circulated within the cabin. Part of the used air is pushed out through the vent in the cabin. This creates a typical sauna climate which can achieve temperatures of approx. 110°C measured directly under the ceiling of your sauna, dropping in temperature to approx. 30-40°C towards the floor. It is therefore not unusual to measure temperatures of 110°C on the temperature sensor hanging over the heater, whilst the thermometer hanging on the sauna wall, approx. 20-25 cm under the cabin ceiling, only indicates 85°C. The bathing temperature generally lies between 80°C and 90°C in the area of the upper bench when the temperature is set to maximum.

Please note that the highest temperatures are always generated over the sauna heater and that the temperature sensor and the safety limiter must be mounted there in accordance with the control unit installation instructions.

When heating up for the first time, you may notice a slight smell caused by evaporating lubricants used in production processes. Please ventilate your cabin before beginning your sauna bath.

Important notes

-  Unprofessional installation may cause a fire hazard! Please read these installation instructions carefully. In particular, please observe the dimensions stated and the following notes.
- This unit is not intended for use by persons (including children) with restricted physical, sensory or mental capacity or by persons without the necessary experience and/or knowledge, unless they are supervised by someone responsible for their safety or receive instructions from them on how to use the unit.
- Children should be supervised to make sure that they will not play with the unit.
-  Only specialists may install and connect the sauna heater, control unit and other electrical operating resources with a fixed mains connection. The necessary protective measures according to VDE 0100 of § 49 DA/6 and VDE 0100 part 703/2006-2 must be observed.
- Sauna heater and control unit may only be used in sauna cabins made of suitable, low-resin and untreated materials (e.g. spruce).
- Only one sauna heater with the required heating output may be installed in the sauna cabin.
- Please provide air intake and vent openings in each sauna cabin. The air intakes must always be positioned behind the sauna heater, approx. 5 to 10 cm above the floor. The minimum dimensions of the air intake and vent openings are stated in the table.
- The vents are always to be positioned offset diagonally to the sauna heater in the lower area of the rear sauna wall. The air intake and vents may not be covered. Please observe the sauna cabin supplier's instructions.
- One of the control units specified below must be used for the regulation or control of the sauna heater. This control unit must be positioned at an appropriate point on the cabin outer wall; the associated sensor casing must be positioned inside the sauna cabin interior according to the installation instructions included with the control unit.
-  **Caution:** Covers or stone containers which have not been filled correctly are a fire hazard.
-  Every time before the sauna is used, please ensure that no objects have been left lying on the

sauna heater.





-  **Caution:** The high sauna heater temperatures generated during operation can cause burns.
- The sauna heater is not intended for installation or set-up in a niche, under a bench or under a sloping roof.
- Do not put the sauna heater into operation when the air intake is closed.
- The cabin lighting and the corresponding installation must correspond with the "splash protected" version in accordance with DIN EN VDE 0100 T 703. Therefore, only VDE-tested sauna light with max. 40 Watt may be installed in connection with the sauna heater.

-  Only a locally certified electrician may connect the sauna facility (sauna heater, control unit, lighting etc.) to a fixed mains connection.
- All electrical installations and all connection lines that are installed inside the cabin must be suitable for an ambient temperature of at least 170 °C. If single-wire cables are used as connection lines, they must be protected using a flexible metal tube connected to the equipment grounding conductor.

Please see the table for the minimum cross-section of the connection cable and the suitable cabin size in relation to the power input in kW.

- When installing the sauna heater, please ensure that the vertical clearance between the sauna heater upper edge and the sauna ceiling is maintained. Please see also the dimensions diagram for the clearance between the lower edge of the sauna heater and the floor. On heaters with bases, this clearance is maintained via the base or legs of the device.
- Please always ensure that the sauna heater is never placed on flooring made of flammable material (wood, plastic flooring etc). Ceramic tiles are recommended as floor materials.
- Floor heating in the sauna cabin increases the surface temperature of the flooring.
- Please see the dimensions information for the respective sauna heater for the clearance between the heater protective grating or the bench and other flammable materials. The heater protective grating must roughly accord with the front height of the sauna heater.
- Please also observe the informa-

tion and instructions provided by the cabin manufacturer.

-  Please take precautions when cleaning components with sharp edges.
- Upright heaters need to be fitted on site with elements that prevent them from overturning.
-  **Attention:** Pour the infusion water only on the sauna rocks and never anywhere else.
-  When using your sauna in a dry Finnish mode never add sauna essences or place any herbs into the vaporizer holder for essences/herbs. **Risk of fire!**
-  Never add more essences or volatile oils than advised on the packaging. Never use alcohol or undiluted concentrates. Caution! **Fire hazard!**

Electrical connection

Using the above-mentioned wiring diagram and the information on the wiring circuit adhered to the respective control system, your electrician will be able to connect the system without further instructions.

Please note that, for safety reasons, power cables may not be laid visibly on the interior walls of the cabin. Most sauna cabins have empty ducts fitted into the wall element with the air intake.

If no empty ducts are available in your cabin, drill a sufficiently sized hole in the cabin wall directly next to the place where the cable exits the sauna heater and guide this cable outside through the hole to the control unit. The cable, and all other connecting cables (mains power cables and cabin lighting), should be installed in installation ducts or also be protected against damage on the outside of the cabin e.g. by laying them in installation pipes or attaching wood cover strips.

The sauna heater may only be used in combination with a protective cover or S-guard system if operated by remote control*

**Remote control = Setting, control and/or regulation of the device by means of commands entered when the device is out of sight. Telecommunication, sound technology or bus systems can be used.*

Caution!

Dear Customer,
In compliance with the valid regulations, only certified electricians may connect the sauna heater and the sauna control system to the mains power supply. Please note that you must provide a copy of the invoice from the electrical company who installed the sauna in case of a warranty claim.

Example of connections for Mythos sauna heaters

7,5 - 9 kW

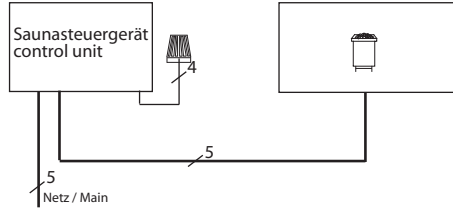

7,5 kW

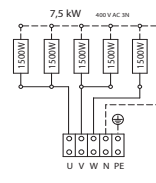

9 kW

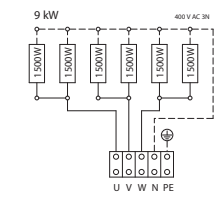

12 - 15 kW

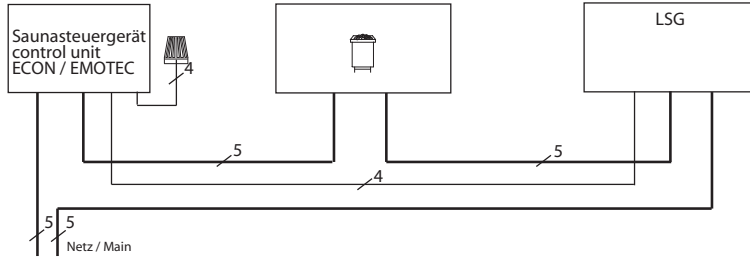

12 kW

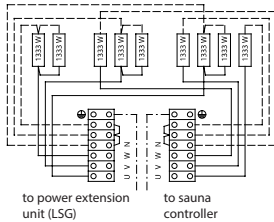

15 kW

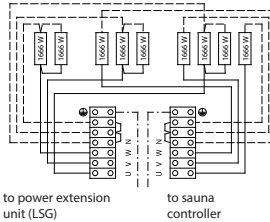

Attention! Always connect the neutral wire N.

| Heater power as per DIN | Electrical connection | Fuse protection of controller, A | Fuse protection of power extension, A | Connection power supply - controller | Connection power supply - power extension | Connection controller - heater | Connection power extension - heater | Connection controller - power extension unit |
|-------------------------|-------------------------|----------------------------------|---------------------------------------|--------------------------------------|---|--------------------------------|-------------------------------------|--|
| 7,5 kW | 3N AC 50 Hz 400 V | 3 x 16 | | 5 x 2,5 | 5 x 2,5 | 5 x 1,5 | | |
| 9,0 kW | | | | | | | | |
| 12,0 kW | | | 3 x 16 | | | | 5 x 1,5 | |
| 15,0 kW | | | 3 x 16 | | | | 5 x 1,5 | 4 x 1,5 |

All cross sections of a line are minimum diameters in mm² (Copper line)

| Heater power as per DIN | Heater dimensions (H/W/D) in cm | For sauna cabin volume | Minimum dimensions of air intake and exhaust vents | Weight without rocks and packaging | Stone filling | Power extension unit (LSG) necessary | For operation with sauna control units |
|-------------------------|---------------------------------|------------------------|--|------------------------------------|---------------|--------------------------------------|---|
| 7,5 kW | 84 / 42 / 37 | 8 - 12 m ³ | 35 x 5 cm | 33,5 kg | 35 kg | no | ECON D1, D2, D3, H1, H2, H3 EMOTEC DC9000 EMOTEC DC9000 DLF EMOTEC HCS 9003 EMOTEC HCS 9003 DLF EmoTouch II PB/AF/GF |
| 9,0 kW | | 9 - 14 m ³ | 35 x 6 cm | | | | |
| 12,0 kW | 84 / 50 / 37 | 14 - 18 m ³ | 35 x 7 cm | 39,5 kg | 45 kg | EMOTEC L09R LSG 18 | |
| 15,0 kW | | 18 - 25 m ³ | 35 x 9 cm | | | | |

Power leakage: max. 0,75 mA per kW heating power

Example of connections for Mythos Vapor heaters (optional)

7,5 - 9 kW

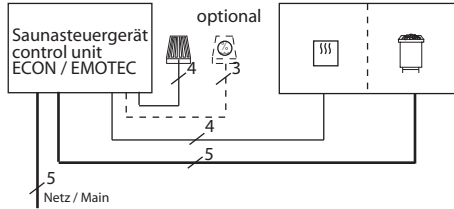

7,5 kW

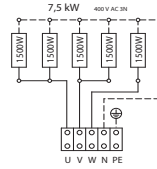

9 kW

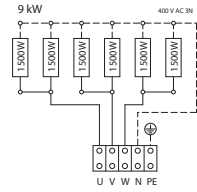

12 - 15 kW

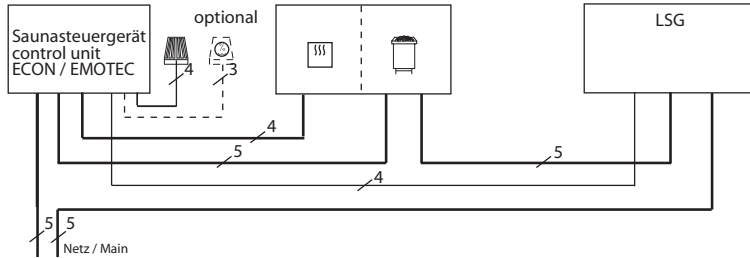

12 kW

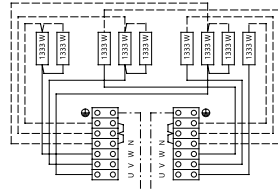

to power extension unit (LSG)

to sauna controller

15 kW

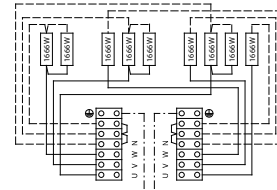

to power extension unit (LSG)

to sauna controller

Vaporizer 2 - 3 kW

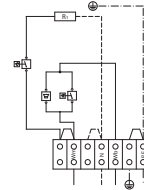

R1 = 2000 W or 3000 W

| Vaporizer power | Electrical connection | Vaporizer water tank volume | Vaporizer dimensions (H/W/D), cm | Vaporizer weight, kg | Connection control unit - vaporizer |
|-----------------|-----------------------|-----------------------------|----------------------------------|----------------------|-------------------------------------|
| 2,0 kW | 230 V 1N 50 Hz AC | 10 l | 84 / 8 / 37 | | 5 x 1,5 mm ² |
| 3,0 kW | | | | | |

All cross sections of a line are minimum diameters in mm² (Copper line)

Installation

Scope of delivery

- 1 sauna heater incl. foot
- 1 set sauna stones (S35 - 35 kg / S45 - 45 kg)

Specifications

Voltage: 400 V AC 3N 50 Hz

Power consumption:

Mythos S35 - 7,5 or 9,0 kW

Mythos S45 - 12,0 or 15,0 kW

depending in the model

Height: 840 mm

Width: S35 - 420 mm, S45 - 500 mm

Depth: 370 mm

Stone filling: S35 - 35 kg, S45 - 45 kg

Leakage current: max. 0,75 mA per kW heating power

Sauna heater for use in domestic and commercial saunas.

The sauna heater, if used in commercial/public facilities and equipped with remote control*, may be used only in combination with the appropriate cover protection system or S-Guard system.

**Remote control – means settings, switching, control and adjustment of the sauna control unit by means of commands transmitted from a remote location beyond sight distance using telecommunication, wire- or wireless signal transmission systems, network and similar systems.*

The sauna heating unit is intended only for a supply voltage of 400 V AC 3N.

Minimum clearances

The minimum height of the sauna cabin must be 1.90m on the inside.

During the installation of the sauna heating unit, make certain that the vertical clearance between the upper edge of the sauna heating unit and the sauna ceiling is at least 90 cm. The horizontal (lateral) clearance between the sauna heating unit and the cabin wall is at least 4 cm (illustr. 1).

The distance between the oven safety grid or recliner bench and other flammable materials and the sauna heating unit is at least 4 cm. The safety grid height must be approximately equal to the frontal height of the sauna heating unit.

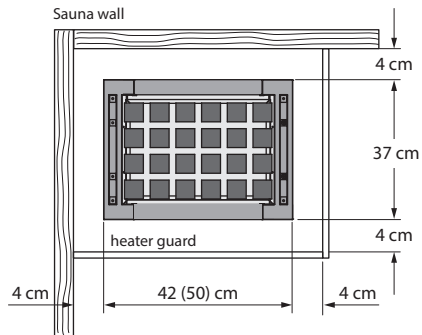

Illust. 1

Heater foot sealing installation

To provide for due stability of the heater glue the supplied self-adhesive strips into the grooves on bottom of the foot. Remove the protective foil from the strips before gluing them to the foot. See Illustr. 2 for details.

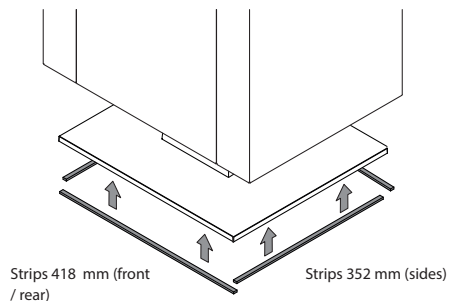

Illust. 2

Cable connections

The connection terminal block is located at the rear side in the lower part of the heater.

To access the terminal block proceed as follows (Illust. 3):

- Remove 2 fastening screws at the top inner side of the rear wall panel.
- Carefully slide the rear wall panel upwards and take it out from the holders.
- Remove 2 securing screws at the covering lid of the terminal block and take the lid off.
- Connect cables in accordance with the circuit diagram. The circuit diagram is located in the terminal box. Ensure that all connections are tightened properly.
- Connect the heater to sauna control unit or also to power extension unit by models > 9 kW. Make sure to observe the applicable local codes and norms, as well as the VDE norms.
- Close the terminal box with the covering lid and to secure it with the fastening screws.

After making necessary connections re-install the rear wall in reverse order. The connection cable will face downwards and shall be drawn along the foot to the sauna controller / LSG unit.

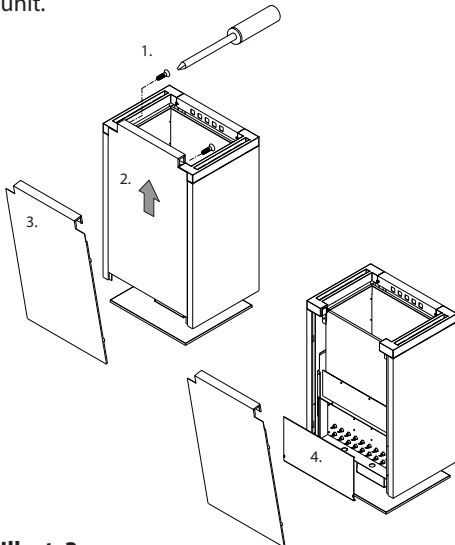

Illust. 3

Installation of Cubic stones (optional)

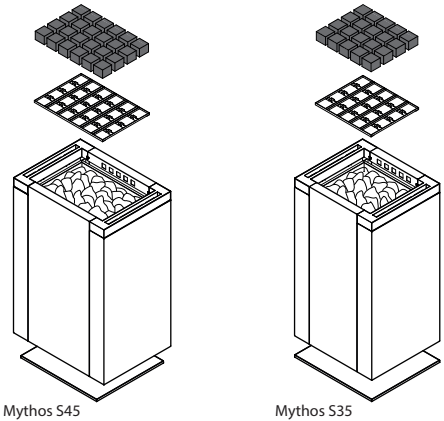

Illust. 4

Optional Cubic stone sets:

- For Mythos S35 - item 94.5520
- For Mythos S45 - item 94.5521

The optionally available Cubic stones perfectly complete the cubistic design of the exclusive Mythos sauna heaters and also enhance the steam shock experience of a traditional Finnish sauna.

At first fill the conventional sauna stones into the rock store so that 1 cm is left free to the upper edge of the rock store. If some stones are left, leave them for the future replacements.

Place the metal holder frame for Cubic stones on the rock store and insert the Cubic stones into the corresponding slots.

Ensure that the frame is securely placed on the rock store and has no contact with the underneath conventional sauna stones.

You can make water splashes as usually. Pay attention to that thanks to the flat surface of the Cubic stones the splashed water will partially flow down between them into the main stone compartment and will evaporate there. Check the Cubic stones regularly for possible damages and replace them with the new ones if necessary.

Dry Finnish sauna operation

In this mode the vaporizer is not in use. **It is imperative to ensure that there are no herbs or essence in the holder, because they could dry out and catch fire.** Essences or any other kind of additives to be added to the water shall be used only according to the manufacturers instructions.

By water infusion do not pour the water too quickly over the rocks, pour them slowly with the sauna ladle. This ensures that the water vaporises completely so you can enjoy the full effect of „loylu“ (water infusion).

Never add more sauna essences or additives to the infusion water than indicated on the pack. Never use alcohol or undiluted infusions. Danger! There is a risk of fire.



Attention: Pour the infusion water only on the sauna rocks and never anywhere else.



When using your sauna in a dry Finnish mode never add sauna essences or place any herbs into the vaporizer holder for essences/herbs. **Risk of fire!**

Humid sauna operation

only for „Vapor“ model with vaporizer

The Mythos Öfen are optionally available with a 2 kW or 3 kW vaporizer, which may be attached to the heater on the right or left side.

For all details concerning instalation, connections, operation and maintenance please refer to the separate manual „Mythos vaporizer“.

Please consider that for the operation of the vaporizer you will need an appropriate sauna control unit supporting dry and humid sauna operation modes.

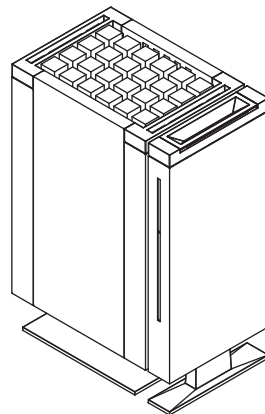

Sauna rocks

Sauna stones are a natural product. Check the sauna stones at regular intervals. Aggressive sauna essences can weaken the sauna stones and cause them to break apart over time. Consult your sauna supplier if necessary.

Rinse the sauna stones provided under running water and then place them in the stone compartment so that the convection air flow can circulate easily between the stones (Illust. 9 + 10).

The quantity of stones is sufficient to create a steam shock, vaporizing about 10 cl of water per m³ cabin volume. Always wait 10 minutes after infusion before repeating the infusion. Only then the sauna stones will re-heat sufficiently again.



Never add more essences or volatile oils than advised on the packaging. Never use alcohol or undiluted concentrates. Caution! **Fire hazard!**

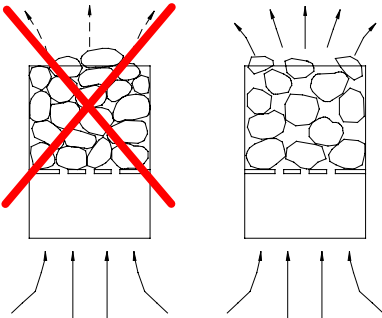

Maintenance and care

All sauna heating units are made of low-corrosion material. To enjoy your sauna heating unit for a long time you should ensure maintenance and take due care about the heater. Always make sure that the air supply vents and reflection surfaces in the area of air intake are free. These can easily become clogged with fuzz and dust when drawing in fresh air. This reduces the air convection in the sauna heating unit and can be a cause of too high temperatures.

Clean or de-scale the heater when needed. Refer to your sauna supplier or directly to the manufacturer in case of defects or signs of wear and tear.

Only use original manufacturer's replacement parts, which can be obtained from your supplier or directly from the manufacturer.

If you did not use your sauna for a long period of time, always check before next use that cloths, cleansers or other objects have not been left on the sauna heating unit or the vaporizer before turning them on.

Please be sure to note!

Do not insert sauna rocks too tightly in the rock store. Place them loose, leaving as many spaces as possible to allow the free flow of hot air for circulation purposes.

Remove stones from the sauna heater only when they cooled down.

It cannot be excluded that hot rocks or their parts fall out of the rock store. **Risk of fire!**

For the installation of sauna heaters, please pay attention to the DIN VDE 0100 part 703 !

This standard makes the following statement valid in your newest expenditure, since February 2006, paragraph 703.412.05; Quotation:

The additional must be planned for all electric circuits of the Sauna by one or more fault current protection device (RCDs) with a calculation difference stream not more largely than 30 mA, excluded of it is Saunaheating.

The EN 60335-1 DIN VDE 0700 part 1 of January 2001 states the following in paragraph 13; quote:

The leakage current may not exceed the following values during operation:

- for stationary heaters of protection class I 0,75 mA; or 0,75 mA each kW input of the appliance, depending on the higher value, at a maximum value of 5 mA.

If the appliance is equipped with a protective device for leakage current (ELCB), please pay attention to the fact that no other electrical units will be protected by this ELCB.

Under current manufacturing technology, it is not reasonable to use heating elements for sauna heaters which do not collect moisture from the surrounding air. It is therefore possible that a little bit of moisture from the surrounding air may reach the magnesium-oxide filling in the heating elements during transport or storage and may cause the ELCB to release.

In this case the oven must be heated up under supervision of an expert, during which the PE conductor is not connected. After about 10 minutes, when moisture has evaporated from the heating elements, the oven must be reconnected to the PE conductor!

If the sauna heater is not in use for a significant period of time, we recommend running it every 6 weeks, so as to avoid moisture concentrating in the heating elements.

Therefore, should the ELCB be released during start-up, the electrical installation must be checked.

Installation of the sauna heater and control unit must be undertaken only by an authorized electrician. **Without a documented proof of such installation a warranty is generally void.**

Please keep this address in a safe place together with the installation guide.

To help us answer your questions quickly and competently please provide the information printed on the type shield including the model, item no. and serial no., in all inquiries.

Service Address:

EOS Saunatechnik GmbH
Adolf-Weiß-Straße 43

35759 Driedorf-Mademühlen, Germany

Tel: +49 (0)2775 82-514

Fax: +49 (0)2775 82-431

servicecenter@eos-sauna.de

www.eos-sauna.de

WARRANTY

The warranty is provided according to the legal regulations at present.

Manufacturer's guarantee:

- The period of guarantee starts from the date of purchase and lasts up to 2 years by commercial use and 3 years by private use.
- Always include the completed guarantee certificate when returning equipment.
- The guarantee is void for appliances which have been modified without manufacturer's explicit agreement.
- Damages caused by incorrect operation or handling through non-authorized persons are not covered under the terms of guarantee.
- In the event of a claim please indicate the serial number as well as the item number and model name with detailed description of the fault.
- This guarantee covers defective parts and labour but not the defects caused by wear and tear.

In case of complaint please return the equipment in its original packaging or other suitable packaging (caution: danger of transport damage) to our service department.

Always include the completed warranty certificate when returning equipment.

Possible shipping costs arising from the transport to and from point of repair cannot be overtaken by us.

Outside of Germany please contact your specialist dealer in case of warranty claims. Direct warranty processing with our service department is in this case not possible.

Equipment commissioning date:

Stamp and signature of the authorized electrician:

Handling procedures for return shipments (RMA) - Details for all returns !

Dear customer

we hope that you will be satisfied with the purchased EOS product. In the rear case if you may have a claim and will need to return a product, please follow the procedures specified below. This will enable to ensure a quick and effective handling of the return shipment.

Please observe for all returns!

- Please add the provided **RMA-voucher completely filled out** together with an **invoice copy** to the return shipment! Do not stick it on the goods or on the packaging. **We do not accept return shipments without these papers.**
- Not prepaid parcels **will be refused** and returned to Sender! Please always ask your dealer or EOS service department about the most economical return shipment way.
- **Please pay attention that** the goods have to be sent back in the **original scope of delivery** and in **original packing**.
- We recommend to use an **additional solid and break-proof covering box** which should be padded out with styrofoam, paper or similar. Transport damages as a result of faulty packing are for the sender's account.

Form of complaint:

1) Transportation damage

- Please check the content of your parcel immediately and advise the forwarding company of a claim (parcel service/ freight forwarder)
- Do not use damaged goods!
- Ask the forwarder **for a written acknowledgement of the damages.**
- **Report the claim promptly by phone to your dealer.** He will discuss with you how to act in this case.
- If the transport box has been damaged, please use an additional covering box. Do not forget to add the **acknowledgement of the damage of the forwarding company !**

2) Faulty goods

- The implied warranty period is 2 years. Please contact your dealer in case of **faulty or wrong articles or missing accessories.** He will discuss with you the individual case and try for immediate and customer-friendly solution.
- For **economic returns** within Germany you will get an **RMA-number from the manufacturer.**
- All returns have to be in the **original packing of the goods with corresponding accessories.** Please repack the goods to avoid damages. In case of wrong delivery, please do not use this article .

3) Problems of installation and functioning

- Please **read the manual carefully first of all** and pay attention to the indicated assembly or installation instructions.
- **Your dealer should be the first contact person** because he knows his products best and also knows possible problems.
- **In case of function problems with an article,** please check at first whether there is an obvious material defect. The quality system in our factory reduces malfunctions of new appliances to almost zero.